

SOD-123 Plastic-Encapsulate Diodes

FEATURES

- High breakdown voltage
- Low turn-on voltage
- Guard ring construction for transient protection

MARKING: S9

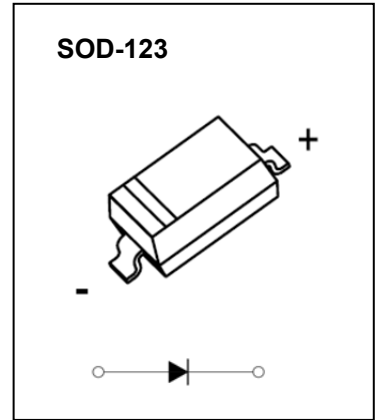

Maximum Ratings @ $T_a=25^{\circ}\text{C}$

Parameter	Symbol	Limit	Unit
Peak repetitive peak reverse voltage	V_{RRM}	100	V
Working peak reverse voltage	V_{RWM}		
Forward continuous current	I_F	150	mA
Repetitive peak forward current (Note 1) @ $t_p < 1.0\text{s}$, Duty Cycle < 50%	I_{FRM}	350	mA
Non-repetitive Peak Forward surge current @ $t = 8.3\text{ms}$	I_{FSM}	750	mA
Power dissipation	P_D	500	mW
Thermal resistance junction to ambient air	$R_{\theta JA}$	200	$^{\circ}\text{C/W}$
Operating Junction Temperature Range	T_j	-40 ~ +125	$^{\circ}\text{C}$
Storage Temperature Range	T_{STG}	-55 ~ +150	$^{\circ}\text{C}$

ELECTRICAL CHARACTERISTICS ($T_a=25^{\circ}\text{C}$ unless otherwise specified)

Parameter	Symbol	Test Conditions	Min	Typ	Max	Unit
Reverse breakdown voltage(Note 2)	V_R	$I_R=100\mu\text{A}$	100			V
Reverse voltage leakage current	I_R	$V_{R1}=1.5\text{V}$			0.3	μA
		$V_{R2}=10\text{V}$			0.5	
		$V_{R3}=50\text{V}$			1	
		$V_{R4}=75\text{V}$			2	
Forward voltage(Note 2)	V_F	$I_{F1}=0.1\text{mA}$			0.25	V
		$I_{F2}=10\text{mA}$			0.45	
		$I_{F3}=250\text{mA}$			1	
Diode capacitance	C_T	$V_R=0, f=1\text{MHz}$		20		pF
		$V_R=1\text{V}, f=1\text{MHz}$		12		

Notes: 1. Part mounted on FR-4 board with recommended pad layout.

2. Short duration pulse test used to minimize self-heating effect.

Typical Characteristics

Forward Characteristics

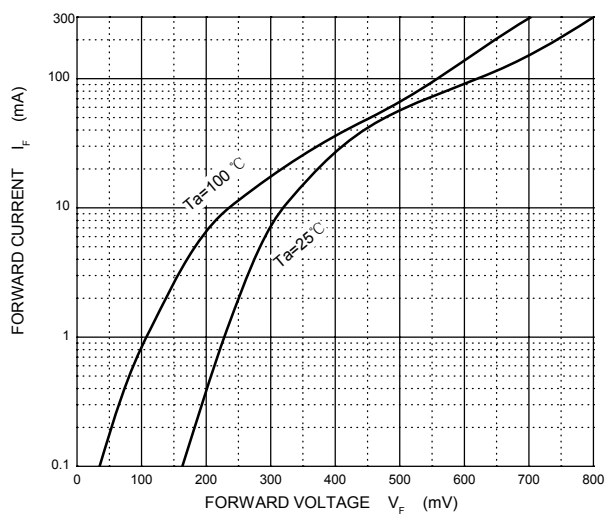

Reverse Characteristics

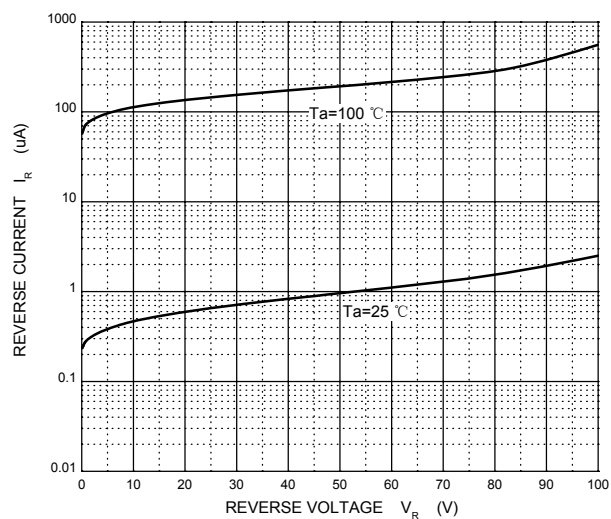

Capacitance Characteristics

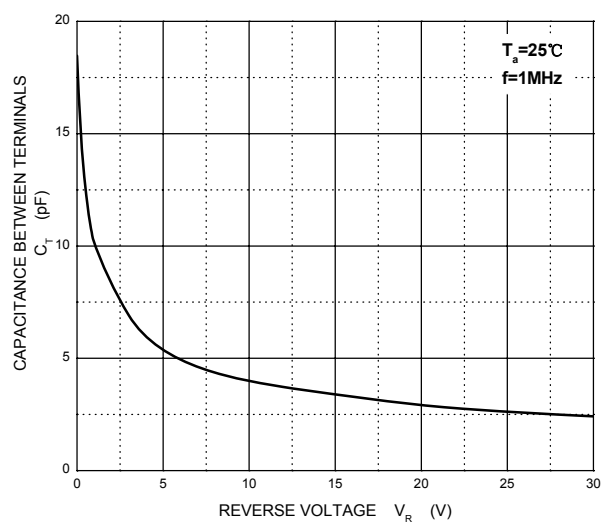

Power Derating Curve

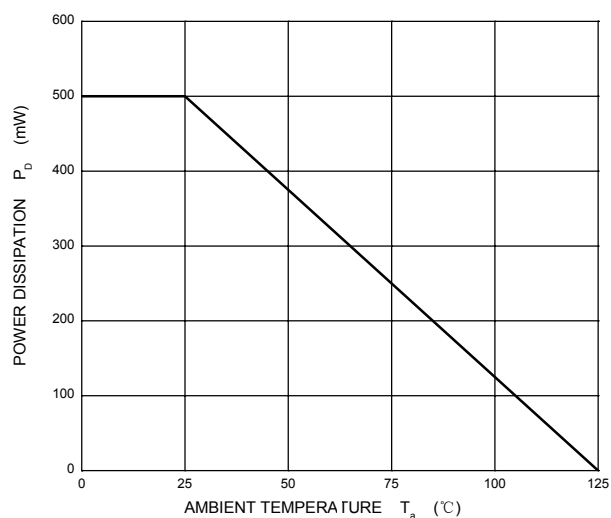

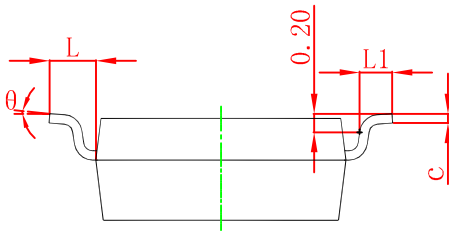
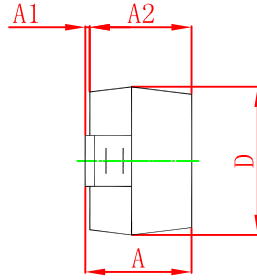
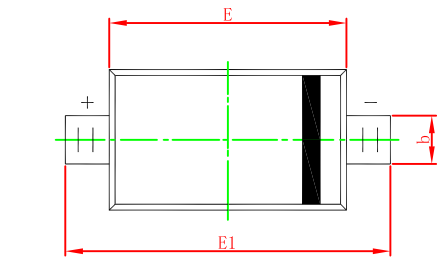

Symbol	Dimensions In Millimeters		Dimensions In Inches	
	Min	Max	Min	Max
A	1.050	1.250	0.041	0.049
A1	0.000	0.100	0.000	0.004
A2	1.050	1.150	0.041	0.045
b	0.450	0.650	0.018	0.026
c	0.080	0.150	0.003	0.006
D	1.500	1.700	0.059	0.067
E	2.600	2.800	0.102	0.110
E1	3.550	3.850	0.140	0.152
L	0.500 REF		0.020 REF	
L1	0.250	0.450	0.010	0.018
θ	0°	8°	0°	8°

SOD-123 Suggested Pad Layout

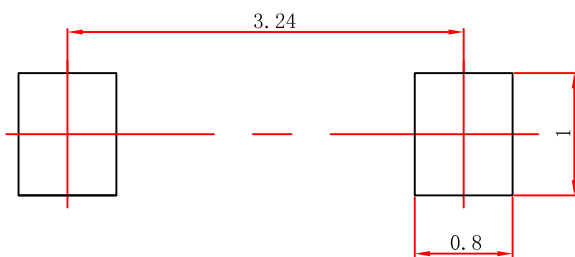

- Note:**
1. Controlling dimension: in millimeters.
 2. General tolerance: $\pm 0.05\text{mm}$.
 3. The pad layout is for reference purposes only.